



Follow us on Facebook



Follow us on YouTube



Follow us on WeChat



Download "Hangcha Forklift" App



ISO45001:2018



ISO14001:2015



ISO9001:2015



HANGCHA trucks conform to the European Safety Requirements.

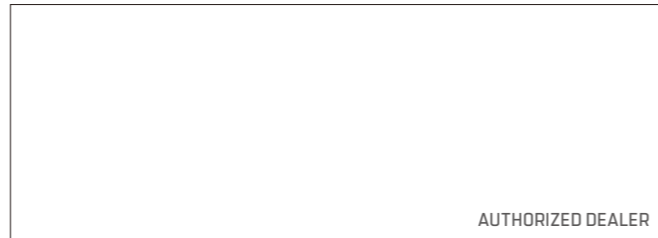

AUTHORIZED DEALER

HANGCHA GROUP CO., LTD.

Factory site: 666 Xiangfu Road, Hangzhou, Zhejiang, China (311305)

Tel: +86-571-88926735 88926755
Fax: +86-571-88926789 88132890

sales@hcforklift.com www.hcforklift.com

HANGCHA GROUP CO., LTD. reserves the right to make any changes without notice concerning colors, equipment, or specifications detailed in this brochure, or to discontinue individual models. The colors of trucks, delivered may differ slightly from those in brochures.

XE SERIES

ELECTRIC FORKLIFT TRUCK WITH LITHIUM POWER

With capacity of 1,500 to 3,800kg

XE
SERIES



XE SERIES



TAKE ON THE BIG JOBS.

Following the family design of electric forklifts, they are provided with some key parts compatible with internal combustion forklifts, and optimized mainly on the overall performance, ergonomics, reliability, maintenance, outdoor operation ability and load capacity in a bid to meet customers' use scenarios of internal combustion forklifts. The enhanced model is capable of meeting the application demand of users in heavy-duty working conditions.

STYLISH EXTERIOR

- Following the family exterior design of XH and XC lithium battery forklifts;
- Boasting smooth and powerful contour lines, and simple and elegant vehicle body, and presenting both fashion and steadiness as a whole.

ENERGY-SAVING AND EFFICIENT

- An efficient high-torque motor together with a high speed ratio gearbox significantly improves the travel speed, gradeability and lifting speed;
- The air-cooled fan built in the travel and lifting motors allow better heat dissipation and more thorough performance realization;
- Oil pump reducers are introduced in the oil pump devices for the first time, enabling the lifting motor to work in a more efficient and more energy-saving manner;



TAKE ADVANTAGE OF MORE POWER

With the **80V dual permanent magnet synchronous motor system** with higher power density, as well the highly fitted speed reducer, motors and electrical control, under the same operating conditions, compared with the traditional asynchronous motor model, the energy consumption is reduced by 15%-20%.

15-20%
ENERGY SAVING

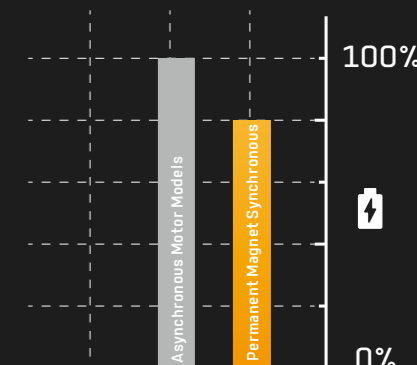



COMFORTABLE EXPERIENCE

- With the advantages of lithium battery forklifts, this ergonomically designed forklift enables a wide view and a large operation space.
- The optional electronic handbrake allows more comfortable driving experience.
- The color-screen instruments are designed to have clear and intuitive graphic interfaces.



Color-screen instruments

Ergonomically designed forklift enables a wide view



ADAPTABILITY TO DIFFERENT SCENARIOS

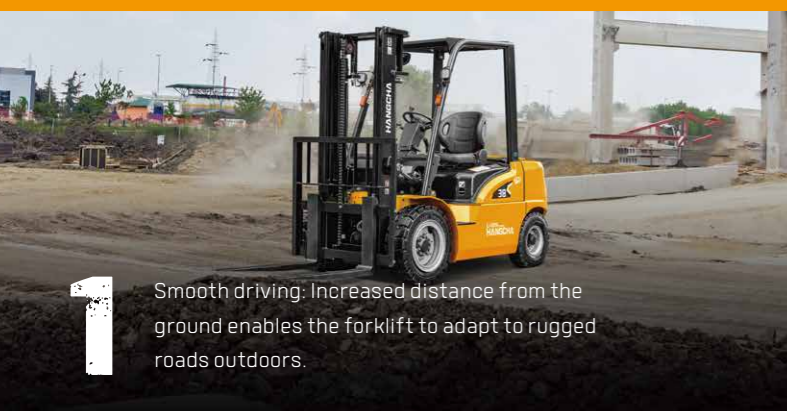

1 Smooth driving: Increased distance from the ground enables the forklift to adapt to rugged roads outdoors.



2 Flexible turning: With a small turning radius, the forklift can flexibly move in indoor environments such as cold stores (optional), etc.



3 Adaptability to cold weather: For the standard configuration, the battery is equipped with an electric heating module to ensure normal operation in cold weather.

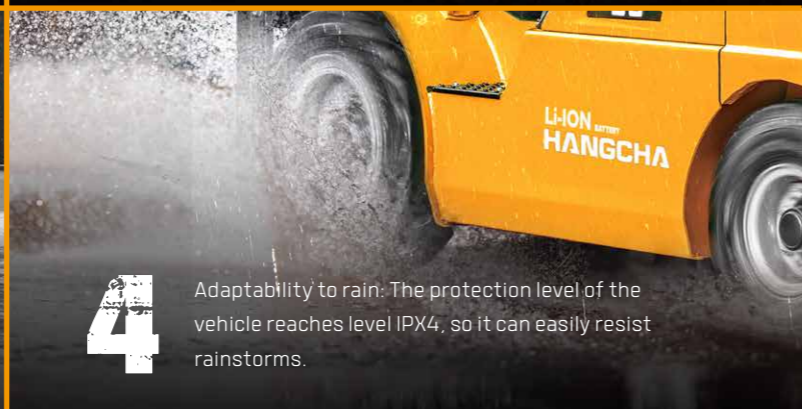

4 Adaptability to rain: The protection level of the vehicle reaches level IPX4, so it can easily resist rainstorms.

RELIABLE AND DURABLE

- The enhanced drive axle and gearbox with the mast, steering axles with tapered roller bearing (for the heavy-duty model) and big tires for internal combustion forklifts can meet the demand of application in heavy-duty working conditions;
- Low center of gravity and high load margin are designed for more stable working;
- Verified in accordance with double standards of electric forklifts and internal combustion forklifts, with the enhanced test strength higher than that for the internal combustion standard, this forklift is reliable and durable.

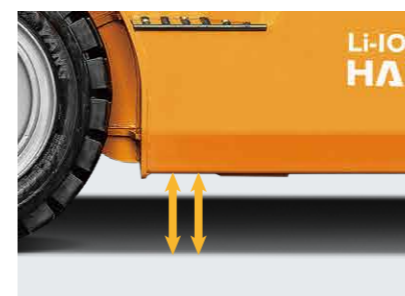

Ground clearance increased



KEEP AN EYE ON EVERYTHING

Hangcha FIMS is a system that provides you with real-time information about forklift truck and driver. Whether you have dozens or hundreds of forklift trucks across multiple sites, you can get access to collecting, monitoring and evaluating all the fleet data at anytime and anywhere.

» Features

- ▶ Access Control
- ▶ GPS Tracking
- ▶ Remote Monitoring
- ▶ Maintenance Reminder
- ▶ Vehicle Management
- ▶ Vibration Monitoring
- ▶ Pre-shift Check (Optional)
- ▶ Shift Management (Optional)
- ▶ OpenAPI (Optional)

LITHIUM POWERED

EMPOWER YOURSELF
WITH THE BEST



Li
Lithium

POWER THE POSSIBILITIES
RELIABLE LITHIUM-ION TECHNOLOGY

LITHIUM BATTERY ADVANTAGES



Long service life

4000 full charging cycles with at least 75% residual capacity.



Return on investment

Add flexibility to your operation, cost-saving in the long term, increased efficiencies.



Maintenance free

No topping up of water or checking acid levels.



High energy density

The high energy density of the Li-Ion battery ensures long working times and increases the high availability.



Cold area application

Li-Ion batteries maintain high performance at temperatures below freezing.



High safety and reliability

Intelligent battery management monitoring every important function, no emission of battery gasses.



Opportunity charging

Full performance during several shifts thanks to effective interim charging.

FEATURES & BENEFITS THE HANGCHA DIFFERENCE

Efficiency

By quick opportunity charging any downtime, such as a lunch break, can be efficiently used and the battery is recharged in a very short period of time. Interim charging does not affect the battery service life.

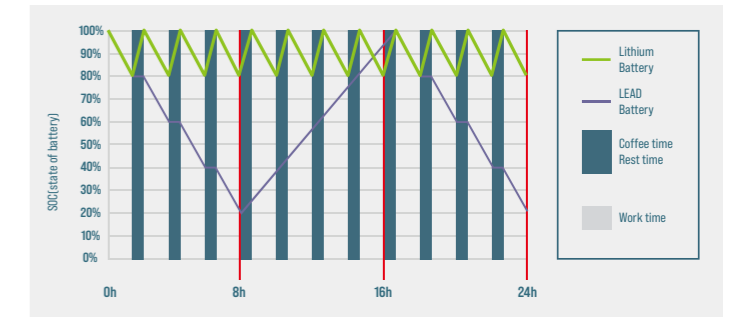

Safety

- / Intelligent battery management monitoring every important function.
- / Higher user safety, thanks to acid-free use.
- / User friendly due to avoided battery change.
- / No emission of battery gasses.

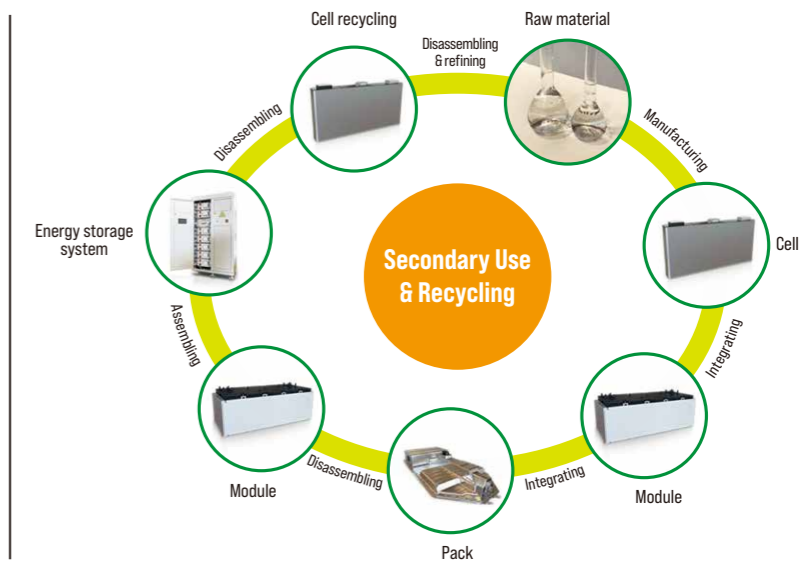

QUESTION 1

Q: What are the characteristics of lithium batteries, especially when used in high and low temperature environments?

Charging temperature: -30 C - 65 C
Discharge temperature: -30 C - 65 C
Storage environment temperature: -30 C - 65 C

After the truck key switch is closed, the instrument battery condition needs to be checked:

1. Confirm that there is no battery system alarm message on the instrument panel.
2. Please check the remaining power before use. It is recommended to use the SOC between 50% and 100%.
3. If the SOC is lower than 20%, it is not recommended to continue using it. Please charge it as soon as possible.

QUESTION 2

Q: What is the charging time and usage time calculation of forklift lithium battery?

1. Available power of lithium battery (kWh) = rated voltage * rated power * 90% (To avoid over-discharge damaging the battery, the forklift is equipped with low power protection [less than 10%]).
 2. Charging time (h) = rated capacity of lithium battery (Ah) * 90% * charger output current (A).
 3. The power consumed for charging (kWh) = the available power of the lithium battery * 93% (the charging efficiency of the charger is calculated as 93%).
 4. Usage time (h) = available power of lithium battery * energy consumption data.
- For specific energy consumption values, please refer to the technical table on the sharing platform.

QUESTION 3

Q: How does Hangcha BMS work to ensure the safety of the lithium battery?

HANGCHA BMS (battery management system) can monitors the cells at all time. As a result, hangcha lithium power is the reliable solution.



Battery Safety Management:

- Overcharge/over discharge protection
- Overcurrent/over-temperature/low-temperature protection
- Multi-level fault diagnosis protection
- Double fault monitoring



Battery Parameter Detection:

- Battery voltage detection and analysis
- Battery current detection and analysis
- Battery temperature detection and analysis



Equilibrium Management:

- Equalization based on voltage mode
- Equalization based on time mode
- Equalization based on battery cell SOC
- Active/passive equalization optional



Other Features:

- Low cost, low power consumption
- Historical data record
- Flexible cascade expansion
- CRC data validation

LI-ION BATTERIES AND CHARGERS

IT'S FASTER AND EASIER WITH HANGCHA

Innovative, reliable lithium-ion technology (Lithium Iron-Phosphate), which are developed jointly by HANGCHA and CATL. Battery cells and modules are from CATL, with reliable quality, exclusively for HANGCHA.



Battery Capacity(Standard)
80V/150-460Ah

Battery weight:150-310kg

Integrated Battery Management System (BMS) continually monitors energy management and ensures reliable operation. HANGCHA provides Li-Ion battery (LiFePO4) with **6 years** or **12000 hours** warranty.

HANGCHA WARRANTY SERVICE

6 YEARS WARRANTY



Charger model:

SLC-80100
SLC-80200

Output voltage range (V):

80V charger: 40Vdc - 100Vdc

Output current range (A):

100A charger: 5A - 100A(SLC-80100)

200A charger: 5A - 200A(SLC-80200)

EVE Battery Capacity

Capacity(Ah)	1.5-mini2.0t 80V		2.0-2.5t 80V		3.0-3.8t 80V	
	HA		HA	H2	HA	H2
150	●	/	/	/	/	/
230	○	●	/	●	/	/
304	○	○	●	○	/	/
460	/	○	○	○	●	/
560	/	/	/	○	○	/
608	/	/	/	/	○	/

Note: ● Standard ; ○ Optional

CATL Battery Capacity

Capacity(Ah)	1.5-mini2.0t 80V		2.0-2.5t 80V		3.0-3.8t 80V	
	HA		HA	H2	HA	H2
228	○	/	/	/	/	/
302	○	○	○	○	○	/
456	/	○	○	○	○	○
604	/	/	/	/	○	○

Note: ● Standard ; ○ Optional

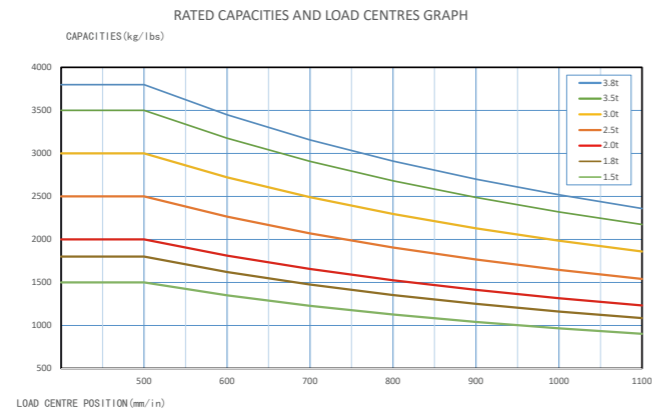
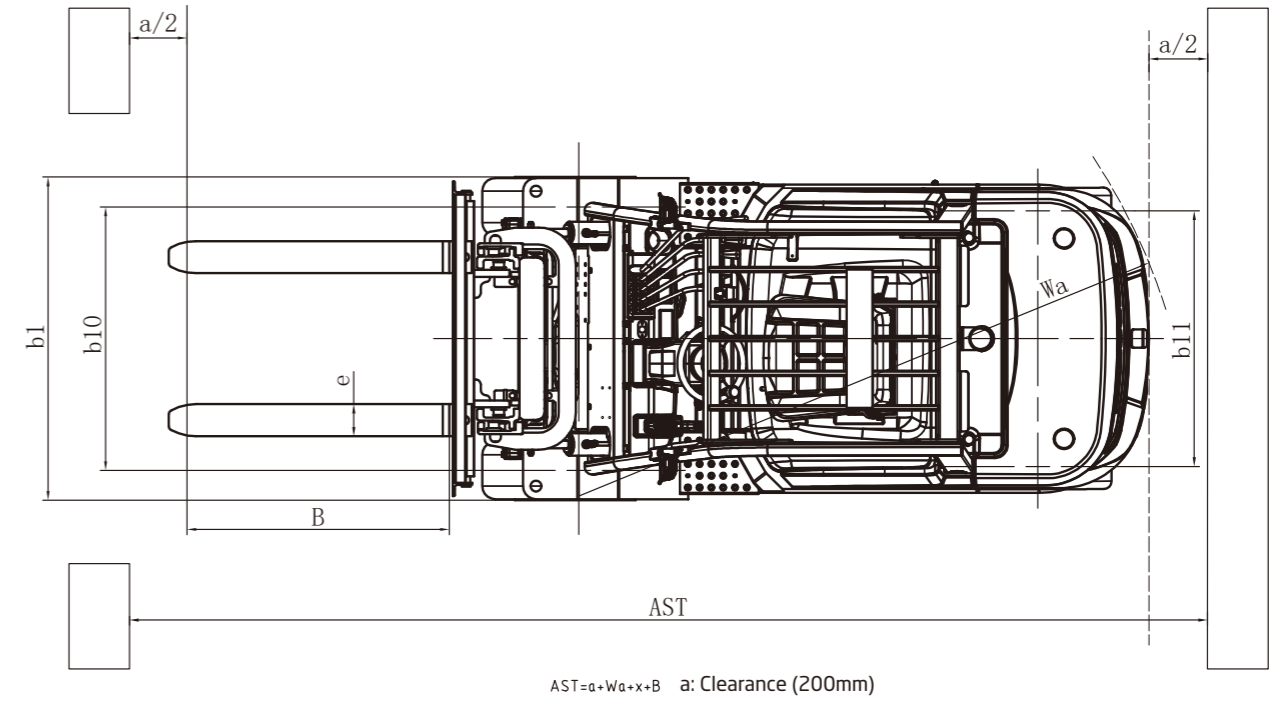
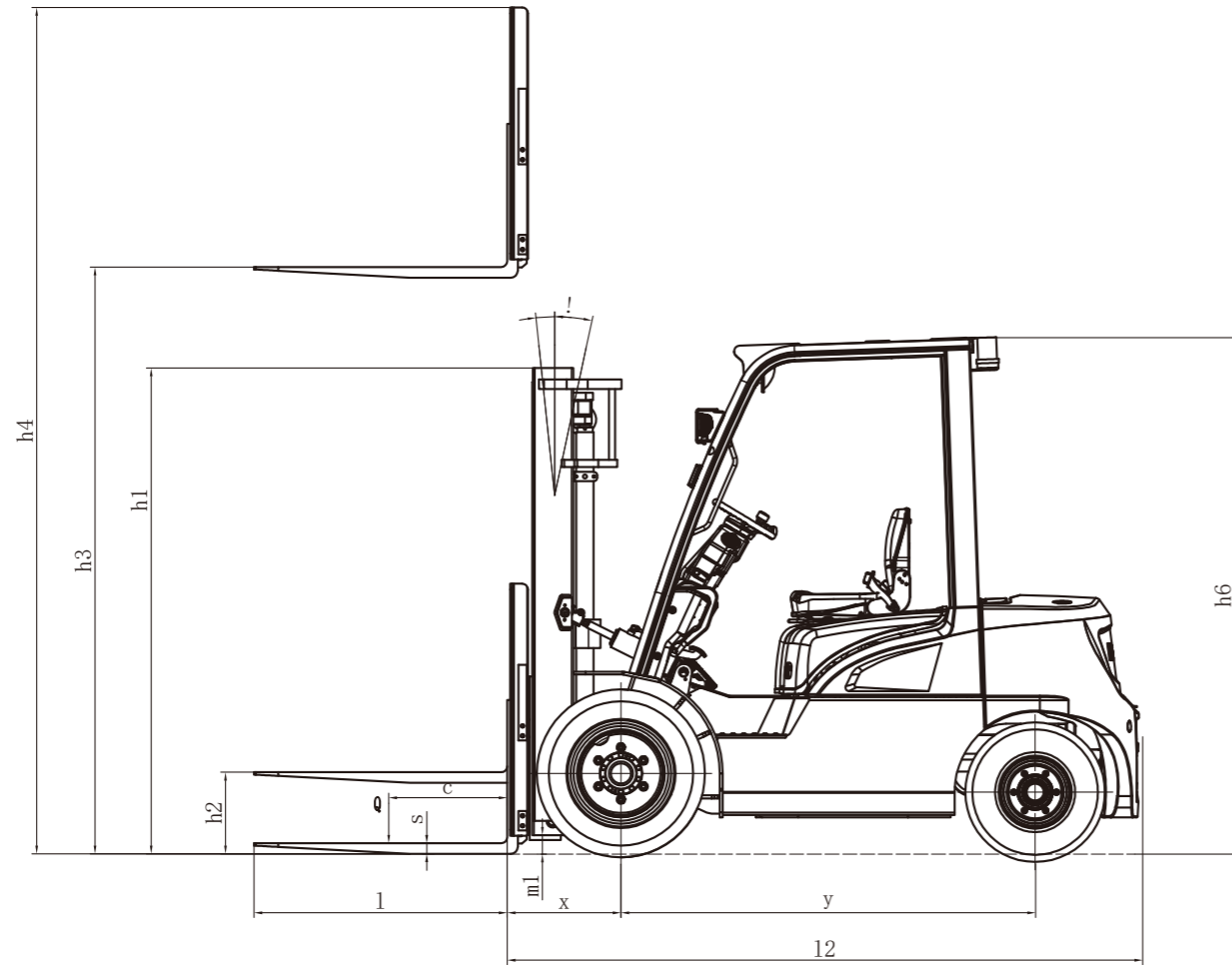

1.5-mini2.0t(HA) Mast specification

Type	Model			Lifting height	Lowered overall height			Overall height				Free lift height				Tilt range FWD/RWD	Capacity (Mast vertical to ground)					
					mm		mm		mm		mm		mm		mm		Load Capacity at 500mm					
					1.5/1.8t	mini2.0t	1.5/1.8t	mini2.0t	1.5/1.8t	mini2.0t	1.5/1.8t	mini2.0t	1.5/1.8t	mini2.0t	1.5/1.8t		mini2.0t	1.5t	1.8t	mini2.0t		
Duplex wide view mast	1.5t	1.8t	mini2.0t	mm	mm	mm	mm	mm	mm	mm	mm	mm	mm	mm	(°)	kg	kg	kg	kg	kg	kg	
	A2A15M200	A2A18M200	XEX20M200	2000	1495	1495	2548	2504	2955	2955	155	160	155	160	6/6	1500	1800	2000	1500	1800	2000	
	A2A15M250	A2A18M250	XEX20M250	2500	1745	1745	3048	3004	3455	3455	155	160	155	160	6/12	1500	1800	2000	1500	1800	2000	
	A2A15M270	A2A18M270	XEX20M270	2700	1845	1845	3248	3204	3655	3655	155	160	155	160	6/12	1500	1800	2000	1500	1800	2000	
	A2A15M300	A2A18M300	XEX20M300	3000	1995	1995	3548	3504	3955	3955	155	160	155	160	6/12	1500	1800	2000	1500	1800	2000	
	A2A15M330	A2A18M330	XEX20M330	3300	2145	2145	3848	3804	4255	4255	155	160	155	160	6/12	1500	1800	2000	1500	1800	2000	
	A2A15M360	A2A18M360	XEX20M360	3600	2345	2345	4148	4104	4555	4555	155	160	155	160	6/12	1500	1800	2000	1500	1800	2000	
	A2A15M400	A2A18M400	XEX20M400	4000	2595	2595	4548	4540	4955	4955	155	160	155	160	6/6	1500	1800	2000	1500	1800	2000	
	A2A15M430	A2A18M430	XEX20M430	4300	2745	2745	4848	4840	5255	5255	155	160	155	160	6/6	1500	1700	1850	1500	1750	2000	
	A2A15M450	A2A18M450	XEX20M450	4500	2845	2845	5048	5040	5455	5455	155	160	155	160	6/6	1500	1650	1850	1500	1700	1900	
A2A15M480	A2A18M480	XEX20M480	4800	2995	2995	5348	5340	5755	5755	155	160	155	160	6/6	1400	1600	1750	1500	1650	1850		
A2A15M500	A2A18M500	XEX20M500	5000	3095	3095	5548	5540	5955	5955	155	160	155	160	6/6	1350	1550	1650	1400	1600	1750		
Duplex full-free mast	A2A15U250	A2A18U250	XEX20U250	2500	1760	1745	3074	3060	3445	3445	1185	1185	815	800	6/12	1500	1800	2000	1500	1800	2000	
	A2A15U270	A2A18U270	XEX20U270	2700	1860	1845	3274	3260	3645	3645	1285	1285	915	900	6/12	1500	1800	2000	1500	1800	2000	
	A2A15U300	A2A18U300	XEX20U300	3000	2010	1995	3574	3560	3945	3945	1435	1435	1065	1050	6/12	1500	1800	2000	1500	1800	2000	
	A2A15U330	A2A18U330	XEX20U330	3300	2160	2145	3874	3860	4245	4245	1585	1585	1215	1200	6/12	1500	1800	2000	1500	1800	2000	
	A2A15U360	A2A18U360	XEX20U360	3600	2310	2295	4174	4160	4545	4545	1735	1735	1365	1350	6/12	1500	1800	2000	1500	1800	2000	
	A2A15U400	A2A18U400	XEX20U400	4000	2560	2545	4574	4560	4945	4945	1985	1985	1615	1600	6/12	1500	1800	2000	1500	1800	2000	
Triplex full-free mast	A2A15N400	A2A18N400	XEX20N400	4000	1960	1945	4694	4655	4955	4955	1276	1392	1015	1000	6/6	1500	1800	1950	1500	1800	2000	
	A2A15N430	A2A18N430	XEX20N430	4300	2060	2045	4994	4855	5255	5255	1376	1492	1115	1100	6/6	1500	1650	1850	1500	1800	1950	
	A2A15N450	A2A18N450	XEX20N450	4500	2110	2095	5194	5037	5455	5455	1426	1542	1165	1150	6/6	1500	1650	1800	1500	1750	1900	
	A2A15N470	A2A18N470	XEX20N470	4700	2210	2195	5394	5237	5655	5655	1526	1642	1265	1250	6/6	1400	1600	1750	1500	1650	1850	
	A2A15N480	A2A18N480	XEX20N480	4800	2260	2195	5494	5337	5755	5755	1576	1642	1315	1250	6/6	1400	1600	1750	1500	1650	1850	
	A2A15N500	A2A18N500	XEX20N500	5000	2360	2295	5694	5537	5955	5955	1676	1742	1415	1350	6/6	1400	1550	1700	1450	1600	1800	
	A2A15N550	A2A18N550	XEX20N550	5500	2560	2445	6194	6037	6455	6455	1876	1892	1615	1500	3/6	1250	1500	1650	1350	1550	1750	
	A2A15N600	A2A18N600	XEX20N600	6000	2810	2645	6694	6537	6955	6955	2126	2092	1865	1700	3/6	1100	1300	1450	1150	1400	1500	

SUBTRACT 100kg WITH INTEGRAL SIDESHIFTER, SUBTRACT 150kg WITH EXTERNAL SIDESHIFTER.

Features

Color	Standard	Options
Yellow-black	●	
Other customized color		○
Particular market		
CE Standard		○
Cold storage environment		
-30°C		○
Mast		
Standard duplex mast	●	
Configuration Table of the Mast		○
Fork and attachment		
Standard fork	●	
Fork arm carrier	●	
Load backrest	●	
Non-standard series fork		○
Various attachments		○
Tires		
Pneumatic tire (single)	●	
Pneumatic tire (dual)		○
Solid tire (single)		○
Solid tire (dual)		○
Multiway valve		
Double multi-way valve	●	
Potentionmeter for lift	●	
3rd vavle		○
4th vavle		○
5th vavle (2.0-3.8t)		○
Tiller		
Lifting and tilting level	●	
Fingertip system		○
Battery		
Standard lithium battery	●	
Large-capacity lithium battery		○
Quick-change lithium battery		○
Light		
LED head lamp	●	
Turn signal lamp	●	
LED rear combination lamp	●	
Common alarm lamp		○
Acoustic and optical alarm lamp		○
LED rear lamp		○
Blue light		○
Straight projection lamp		○
Horn		
Electric horn	●	
Reverse buzzer	●	
Right rear armrest with horn button		○
Smart module		
FIMS[Fleet intelligent management system]		○

Features

Safety configuration	Standard	Options
Emergency power-off switch	●	
Fuse box	●	
Soft landing	●	
Reversing radar		○
OPS system		○
Fire extinguisher		○
Ascending buffering		○
Parking brake		
Mechanical handbrake	●	
EPB[Electric Parking Brake]		○
Instrument rack space		
Smart color-screen instrument (speed mode selection)	●	
Combination switch	●	
Cigarette lighter		○
USB port		○
Electronic code lock (start by swiping a card)		○
Driving space		
Standard overhead guard	●	
Central rear view mirror	●	
Front windshield		○
PVC ceiling		○
Cab		○
Electric fan		○
Left and right rear view mirrors		○
Seat		
Standard seat	●	
Fully-suspended seat		○
Semi-suspended seat		○
Other standard configuration		
Drive and lifting controllers	●	
Driving and lifting motors	●	
Silent gear pump	●	
DC-DC converter	●	
Pedal pad	●	
Traction pin	●	
Integral stamped side panel and hood	●	